

## PRODUCT OVERVIEW

Elgar's AT 8000A/B programmable multi output DC power system accepts both power supply and electronic load modules simultaneously in a single high density 5-1/4" mainframe.

Up to six fully independent channels of linear DC power and/or DC loads can be accommodated in one 19" wide rackmount chassis. The system can be expanded to 16 channels in master/ expansion chassis configurations. It can be controlled either locally from the front-panel keyboard or remotely via IEEE-488 GPIB using one selectable bus address. With the built-in test option, readback capability is available for voltage and current readings on DC power modules, Auxiliary Drive Modules (ADM's) and electronic DC loads.

## FEATURES AND BENEFITS

### HIGH DENSITY MAINFRAME

Six 200W DC power supply modules and/or 300W electronic loads can fit into one 5-1/4" mainframe. By paralleling power modules, a single chassis can deliver up to 1200W. Up to 16 independent channels of DC power can be controlled on a single selectable GPIB address for up to 19.2 kW in a multi-chassis system.

### POWER AND ELECTRONIC LOAD MODULES IN THE SAME CHASSIS

AT 8000A/B can house both DC power and electronic load modules in the same chassis, operating simultaneously. DC power systems for ATE applications can be configured in one package that would otherwise require a multiple chassis solution.

### FRONT PANEL KEYBOARD/DISPLAY

A 16-pad multi-level keyboard features increment/decrement keys plus LED's and displays to speed and simplify programming. The system can show programmed values or, with the built-in test option, actual measured values of voltage and current as well as channel numbers, disconnect status, sense status and modes of operation.

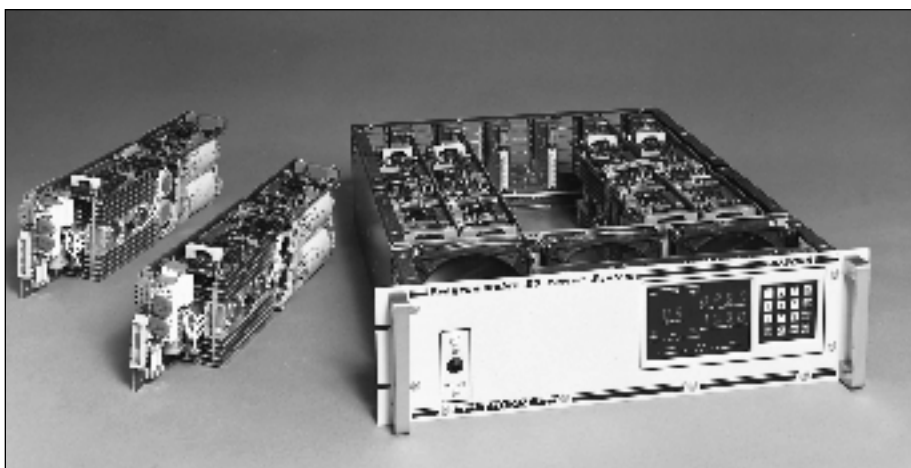

AT 8000A

### INTERNAL PROGRAMMER

A choice of either ABLE (Atlas Based Language Extension) or optional CIIL (Control Interface Intermediate Language) for MATE applications provides complete voltage, current and general system control via the IEEE-488 GPIB.

### LOCAL/MANUAL CONTROL

The AT 8000A/B allows local or manual control of most functions, alerts the operator to identified system malfunctions and provides prompting for ease of programming and operation.

### PROGRAMMING

Atlas Based Language Extension (ABLE) provides simple, easy to use mnemonics for concise programming. Control Interface Intermediate Language (CIIL) conforms to U.S. Air Force MATE guidelines. See the AT 8000A manual for a complete list of ABLE and CIIL syntax.

### AT8000B SERIES

CE For special ATE applications requiring European CE marking, we offer the AT 8000B Series. Designed as a modular DC voltage system, it is provided with GPIB programming (contact the factory for front panel programming options), and provides the same features of the standard AT 8000A series. Voltage modules up to 80 VDC are available. Contact the factory for further details.

### APPLICATIONS

Elgar's modular AT 8000A system offers fully programmable DC power modules and DC loads. The principal applications for the AT 8000A are ATE in production test environments, incoming inspection, repair facilities and quality control where it can be used to provide power stimulus for subassemblies or PCB's. Configured as a load system, the AT 8000A enables the end-user to perform the dynamic loading of DC power supplies, which insures proper operation under worst case scenarios.

### DC POWER MODULES

- DC power supply margin testing
- Component testing

### ELECTRONIC LOADS

- Power supply testing
- Battery capacity testing
- Capacitor discharge testing

### ADM

- Bulk DC supplies
- Programmable disconnect relays



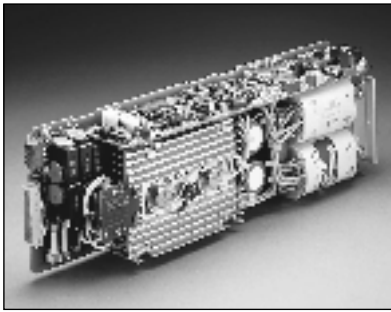

DC POWER MODULE

## DC POWER MODULES

DC modules employ a highly efficient linear design for fast response time and low ripple. Eight standard voltage ranges are available: 0 to 7, 10, 20, 32, 40, 80, 160 and 320 VDC. The design makes modifications for special voltage ranges possible as an option (consult factory). Outputs are completely isolated and all modules operate in constant voltage or constant current mode. Overcurrent sensing and overvoltage protection with SCR crowbar shutdown are standard, as well as load isolation (confidence) relays. Polarity switching relays are optional.

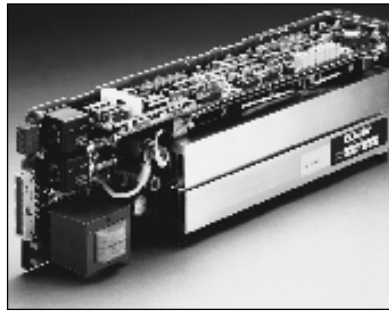

DC LOAD

## ELECTRONIC DC LOADS

300W electronic DC load modules for the AT 8000A simulate real-world characteristics for testing, evaluation and burn-in of DC power supplies. They can be used to load DC power sources in any one of four primary operational modes.

### FULL FOUR MODE OPERATION

The four modes are constant current, constant voltage, constant resistance and transient operation.

### PARALLELEABLE LOAD MODULES

The individual 300W load modules can be paralleled for up to 1800W per chassis.

### PROGRAMMABLE SLEW RATES

The loads automatically duplicate the dynamic behavior of real-world load conditions.

## SPECIFICATIONS FOR THE 60L01:

**Maximum power:** 300W continuous

**Voltage range:** 3 to 60V

**Current range:** 0 to 6A, 0 to 60A

**Resistance range:** 0.01 to 100 Ohms

**Modes of operation:** Constant current, constant voltage, constant resistance, and transient operation. Short circuit available from front panel or GPIB.

Contact factory for other load products.

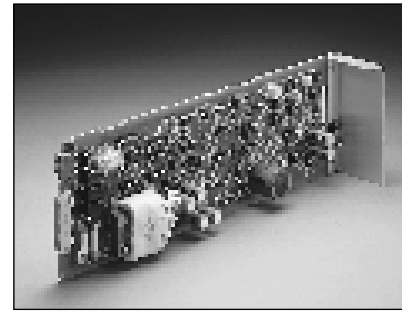

ADM

## AUXILIARY DRIVE MODULES (ADM)

Auxiliary Drive Modules (programmable analog output modules) allow high power Sorensen or other external bulk supplies or loads to be controlled as if they were internal power or load modules. They provide voltage and current programming and relay drivers.

### LIMITLESS POWER

The ADM extends the normal power range of a programmable DC channel to 10 kW or more by using the flexibility of the AT 8000A controller to program high power external power supplies.

### ONE IEEE ADDRESS

Bulk supplies are treated as an additional AT 8000A channel for ease of programming.

### READBACK ON ANY SUPPLY

The ADM can provide BIT-readback of actual voltage and current from the external bulk supply. A current shunt must be provided for proper readback.

### TYPICAL SPECIFICATIONS

Programming voltages may be modified to match user's specific requirements.

**Voltage:** Programmable from 0 to 10 VDC at 1 mA for 0 to full scale voltage control

**Current:** Programmable from 0 to 10 VDC at 1 mA for 0 to full scale current control

**Program Voltage Accuracy:**  $\pm 0.05\%$  of full range voltage and  $+0.05\%$  of programmed voltage

**Resolution:** 1 BIT in 3850 minimum

## SPECIFICATIONS

### OUTPUT

**Output Voltage Range (or compliance range in current mode):** Each power module has a single output voltage range.

**The ranges are as follows:**

- |                |                  |
|----------------|------------------|
| a) 0 to 7 VDC  | (e) 0 to 40 VDC  |
| b) 0 to 10 VDC | (f) 0 to 80 VDC  |
| c) 0 to 20 VDC | (g) 0 to 160 VDC |
| d) 0 to 32 VDC | (h) 0 to 320 VDC |

### Full rated output power:

(See derating chart below)

- a) 200 watts for 20 VDC, 40 VDC, 80 VDC, 160 VDC and 320 VDC modules
- b) 120 Watts for 10 VDC modules
- c) 105 watts for 7 VDC modules

**Configuration:** Up to six output channels per 5-1/4" chassis. Internal programmer controls up to 16 output channels. A maximum of 15 channels can be in separate chassis and be programmed from the "Master" unit at a single GPIB BUS address.

**Voltage Accuracy:** ±0.05% of full range voltage +0.05% of programmed voltage at 25°C

**Current Accuracy:** ±1% of full range at 25°C for master modules. ±2% of full range current at 25°C for master-slave modules

**Maximum Resolution:** 10 mV and 10 mA or 1 part in 3972, whichever is less (resolution) for modules < 100V. 10 mV and 10 mA for modules 100 volts or higher. The resolution of 7 VDC modules is 1.76 mV.

**Readback Accuracy:** ±0.5% of full scale above 1% of full scale for voltage. ±1% of full scale above 1% of full scale for current

**Load Regulation in Voltage Mode:** ±0.01% of full range voltage as measured at sense point for master modules. ±0.05% of full range voltage as measured at sense point for master-slave configurations

**Load Regulation in Constant Current Mode:** ±0.1% of rated short circuit current as measured over rated compliance voltage range (typical)

**Line regulation (voltage mode):** ±0.01% of full rated output for a ±10% line voltage change (typical)

**Line Regulation (current mode):** ±0.05% of full rated output for a ±10% line voltage change (typical)

**Maximum Ripple and Noise (voltage mode):** 1.5 millivolt RMS or .01% of rated output voltage, whichever is greater, from 20 Hz to 100 kHz. Master-slave configurations are 5 millivolts RMS or .01% of rated output voltage, whichever is greater, from 20 Hz to 100 kHz. 15 millivolts peak-to-peak or 0.05% of rated output voltage, whichever is greater, as measured from 20 Hz to 200 MHz. Master-slave

configurations are 15 millivolts peak-to-peak or 0.1% of rated output voltage, whichever is greater, from 20 Hz to 20 MHz (typical).

**Maximum Ripple and Noise (current mode):** 0.1% RMS of rated current of modules, from 20 Hz to 100 kHz (typical). 2% peak-to-peak of maximum rated current of modules, from 20 Hz to 20 MHz (typical)

**Stability (after 30-minute warm-up):** ±0.01% of rated output for 24 hours at constant temperature, line voltage and load conditions

**Temperature Coefficient:** ±0.01% per °C of rated output voltage in voltage mode and ±0.025% per °C of rated output current in constant current mode

**Response to Step Load Change:** Recovers to ±0.1% of final value in 300 microseconds (typical) with a 10% to 100% step in load current

**Overvoltage Protection:** Autotracking with automatic shutdown at 110% of programmed output voltage for programmed voltages from 10% to 100% of range. In current mode, OVP tracks at 110% of programmed compliance voltage.

**Overcurrent Protection:** Autotracking with automatic shutdown at 110% of programmed output current for programmed current from 10% to 100% range

**Nominal Input Line Voltage:** 115 or 230 VAC as selected by rear panel switch

### INPUT

**Input Voltage Range:** ±10% of nominal value

**Input Frequency Range:** 47 to 63 Hz

**Input Circuit Breaker:** Front panel input circuit breaker is provided for protection and as ON/OFF power switch.

### GENERAL

**Operating Temperature Range for Altitude:** To 2000 feet: 0-50°C, 6000 feet: 0-35°C

**Storage Temperature Range:** -40°C to 75°C

**MTBF:** 10,000 hours with six modules operating at rated power output and digital interface in 25°C environment

**Shelf Life:** 5 years minimum

**Humidity:** 0 to 95% non-condensing

**Shock Vibration:** MIL-STD 810 A & B as applicable to shipment of electrical test equipment

**Efficiency:** 50 to 60% at full rated output power at nominal AC input voltage, depending on module voltage

### Insulation Resistance and Dielectric

**Withstanding Voltage:** 50 megaohms at 500 VDC @ 25°C and less than 50% relative humidity

### MECHANICAL

**Size:** 19" (483 mm) wide by 5-1/4" (133 mm) high by 21" (533 mm) deep for mounting in a standard RETMA rack

**Net Weight:** Approximately 80 lbs (36 kg) with six power modules

**Input Power Connection:** Standard three wire, 20A plug; optional: 3 wire MS type connector

**Output Power Connection:** Four wire output via Standard Terminal Strip or optional individual MS connectors (MS3102A) per power module

**Remote Programming Connector:** Via GPIB connector

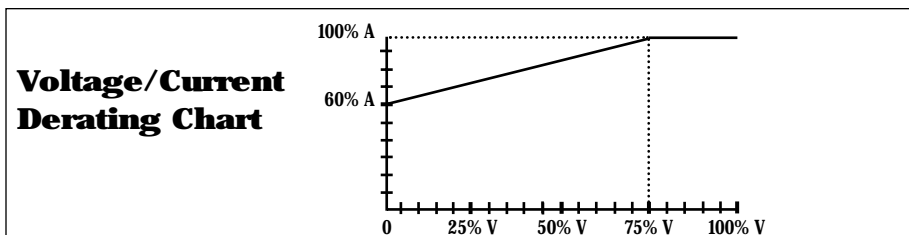

Maximum Full-Scale Ranges			
Max Volts	Max Amps	Max Watts	Current derates linearly from Max A to 60% A, from 75% Max V to 0 V
7	15.00	105	No
10	12.00	120	No
20	10.00	200	Yes
32	6.25	200	Yes
40	5.00	200	Yes
80	2.50	200	Yes
160	1.25	200	Yes
320	0.625	200	Yes

## SYSTEM MODEL NUMBER

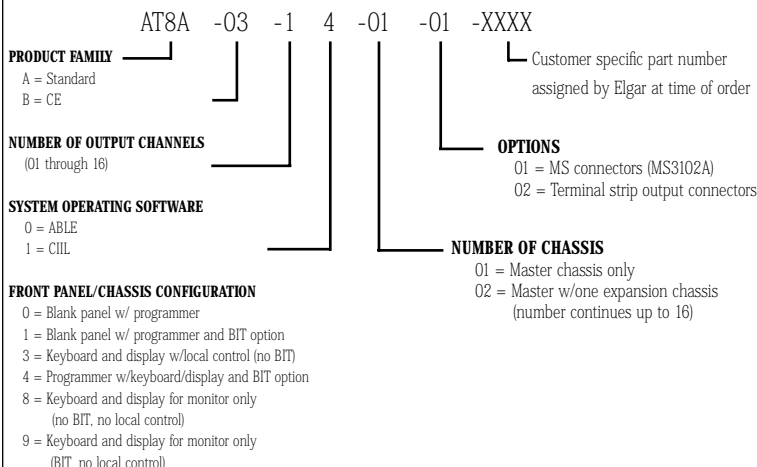

Example: AT 8A-03-14-01-01-XXXX is a 3 output system. Each module has load and polarity relays and one master chassis. It includes CILL programmer, keyboard, display and local control and BIT, and MS output connectors.

## HOW TO ORDER

Please refer to Elgar's price list for prices on individual DC power modules, DC electronic load modules, ADM's, software language, front panel/programmer, system chassis and output connectors. The chart above shows components for the model system number needed for ordering.

## BASIC SYSTEM CONFIGURATION

A basic system can consist of up to 16 output channels controlled by a master programmer at one selectable bus address. The 16 output sub-addresses are conveniently divided into three channel groups: 1-6, 7-12, 13-16.

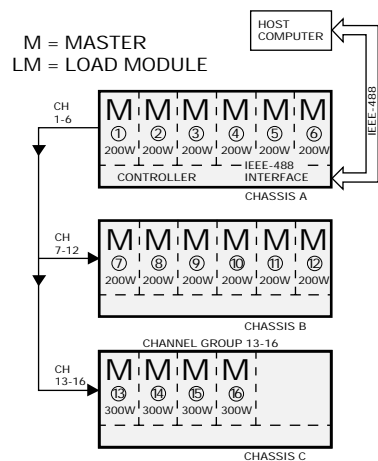

Each 5-1/4" chassis can contain up to six power modules and is switch-selectable for any channel group. A simplified 16-channel system in three chassis is illustrated above. Chassis A contains the GPIB interface, programmer, six 200W power modules individually sub-addressed, and is selected to be channel group 1-6. Chassis B contains six 200W power modules addressed as channels 7-12. Chassis C contains four 300W electronic load modules addressed as channels 13-16.

## COMPLEX SYSTEM CONFIGURATION

The unique master/slave capability and microprocessor-based controller make more complex power applications possible. The illustration below demonstrates the extreme flexibility of the AT 8000A system. Channel groups are not confined to a single chassis. The example shows channel group 1-6 configured in three separate chassis, A1, A2, and A3. The selector switch is set identically in each chassis. A fully populated chassis can be one single channel (e.g. channel one diagram below). A channel can be any combination of up to six modules in parallel or two modules in series operating in master/slave mode.

